

ZBUD LIFTING SOLUTION



ZAKŁAD BUDOWY URZĄDZEŃ DŹWIGNICOWYCH ZBUD Sp. z o.o.

Presents

www.zbud.com.pl



TEL 48 14 644 46 00

TEL 48 644 46 05

FAX 48 644 46 50

marketing@zbud.com.pl

zaopatrzenie@zbud.com.pl

HEADOFFICE

33-200 DĄBROWA TARNOWSKA
UL. ŻABIŃSKA 6
POLSKA



ZAKŁAD BUDOWY URZĄDZEŃ DŹWIGNICOWYCH ZBUD Sp. z o.o.



ZBUD

- Established in 1985 by Ryszard Jędraszek
- Started with 5 people – production of gas heater/nowadays 850 workers
- Turnover average eur 30mln/year
- Own products range – offshore/onshore
- International cooperation based on customers documentation
- Hight focus on



GALLERY



HEALTH SAFETY & ENVIROMENT



HSE
HSE

ZBUD - LIFTING SOLUTION



ZBUD

Early 80's- ZBUD establishment



history



ZBUD Early 90's– new range product
new headoffice



history



ZBUD

Early 90's–new headoffice



history

ZBUD

ZBUD – Nowadays - facilities

27 HALLS - 45 000 SQ. METERS



ZBUD - LIFTING SOLUTION



ZBUD

ZBUD –facilities

- OFFICE BUILDING WITH CONFERENCE ROOMS
- 27 HALLS - 45 000 SQ. METERS
 - 6 steel production halls (40x20m each)
 - 4 machining hall – heavy machines
 - 10 mechanical / HYDRAULIC/ ELECTRCIAL assembly hall (20x20m)
 - 7 painting halls (22x20) 3 shotblasting 18x4 , 5 painting cabins 15x4m
 - Testing facilities up to 110 to ns



ZAKŁAD BUDOWY URZĄDZEŃ DŹWIGNICOWYCH ZBUD Sp. z o.o.



ZBUD

ZBUD –Main customers



ZBUD - LIFTING SOLUTION



ZBUD

ZBUD – FIELDS OF OPERATION

DESIGN

Mechanical, hydraulic, electrical

PROCUREMENT

Highly demanding steel & components

MANUFACTURING

Acc. to DNV, ABS, BV, RMRs etc. Standards

QUALITY

Internal NDT (Level II) laboratory, certified Level III

TESTING

Motion, LOAD, oil contamination, pressure, electrical

INSTALLATION & SERVICE





ZBUD

ZBUD –NOWADAYS

- EMPLOYMENT – 850 people
 - Qualified welding personnel ABS, DNV, UDT
 - Certified Welding Engineers IWE/EWE
 - Internal NDT laboratory (certified level II acc. PN EN 473) / level III authorization
 - Offshore certified Hydraulic, electrical fitters
 - Maintenance and service personnel
- FACILITIES
 - Office buildings with CONFERENCE ROOMS
 - 22 workshops area. 45 000 sqm.
 - Shotblasting/painting- 15 cabins 18x4
 - Hydraulic Assembly – 6 halls 20x45m, 2x 20x48m
 - Testing facilities up to 110t
- MACHINING CENTER–:
 - CNC Horizontal Boring Mills
 - CNC Milling machines
 - CNC turning machines
 - Unique Horizontal Boring Mills DRO
 - LASER/ PLASMA, WATER JET/ Flame cutting machines. DRO
 - Milling machines DRO
 - Lathes, drilling machines, DRO etc.

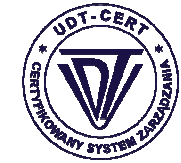

ISO 9001, ISO 3834





ZBUD

ZBUD – DIVISIONS

DOMESTIC PRODUCTION

INTERNATIONAL

COMPLEX PROJECT HANDLING:



DESIGN
STEELWORK
MACHINING
PAINTING
ELECTRICAL ASSEMBLY
INSTALLATION ON SITE
SERVICE



DESIGN
STEELWORK
MACHINING
PAINTING
HYDRAULIC ASSEMBLY
ELECTRICAL ASSEMBLY
TESTING IAT/FAT
INSTALLATION & SERVICE





ZBUD

PRODUCT BY ZBUD

- MANUAL CHAIN HOISTS
- WIRE ROPE HOISTS -THETA
- WIRE AND ELECTRIC ROPE WINCHES
- TROLLEYS
- JIB CRANES
- OVERHEAD CRANES
- GANTRY CRANES
- OFFSHORE PRODUCTS





ZBUD

ZBUD- International offshore main features of steelwork production



- acc, ABS DNV BV LLOYD GL RMRs
- Full traceability of material and components
- Material used from S355 to S690QL
- ABS DNV approved welding technologist
- Welding engineers IWE/EWE
- Certified WPS/WPQR
- Internal NDT laboratory level2 (level3 outsources)
- Unique machining center
- DNV certified Heat Treatment (PWHT) –controlled parameters





ZBUD

ZBUD - PAINTING



- NORSOK M-501 standard
- Control of temp , humidity, dew point (document)
- Company & personel Certified



ZBUD - LIFTING SOLUTION



ZBUD

HYDRAULIC ASSEMBLY PERFORMED BY ZBUD

- Personel certified by GATES HOSE, GSHYDRO, PARKER
- Piping
- Hose crimping
- Flushing (documented)
- Oil contamination test
- Pressure testing (documented)
- Pneumatic system
- WALFORM / JIC37/TRIPLELOCK / EO2 FORM PARKER
- OVERHEAD CRANES CAPACITY 60 T



Return to
PRODUCTION LINE



ZBUD - LIFTING SOLUTION



ZBUD

HYDRAULIC ASSEMBLY PERFORMED BY ZBUD PIPING

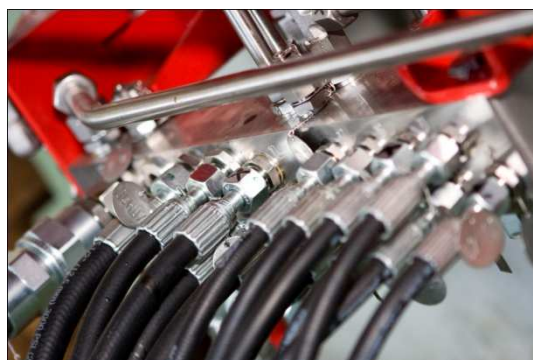
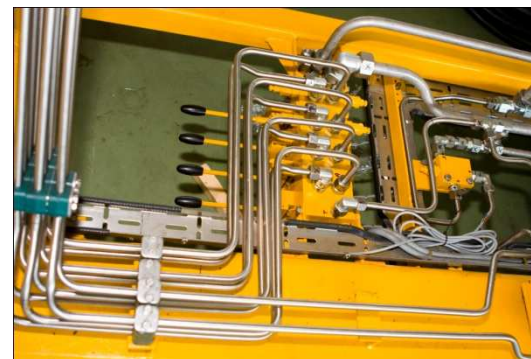



ZBUD HYDRAULIC ASSEMBLY PERFORMED BY ZBUD
HOSE CRIMPING

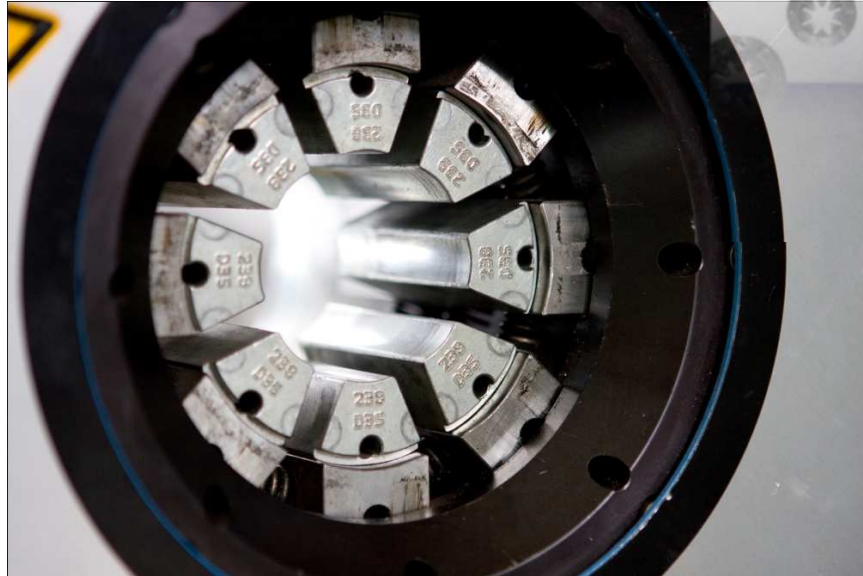



ZBUD

HYDRAULIC ASSEMBLY PERFORMED BY ZBUD
FLUSHING

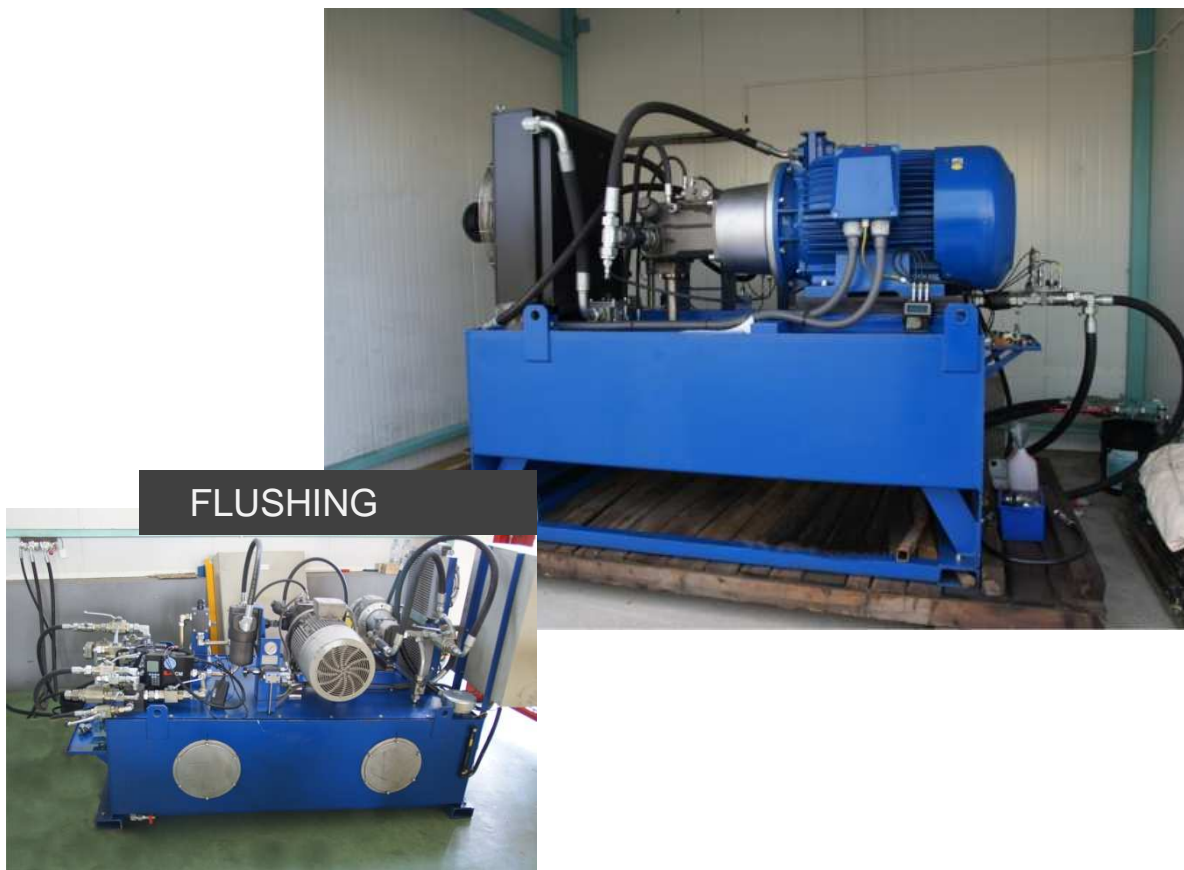

ZBUD - LIFTING SOLUTION



ZBUD HYDRAULIC ASSEMBLY PERFORMED BY ZBUD
OIL CONTAMINATION TEST



OIL CONTAMINATION TEST





ZBUD HYDRAULIC ASSEMBLY PERFORMED BY ZBUD PRESSURE TESTING



PRESSURE TESTING



ZBUD - LIFTING SOLUTION



ZBUD HYDRAULIC ASSEMBLY PERFORMED BY ZBUD PNEUMATIC SYSTEM

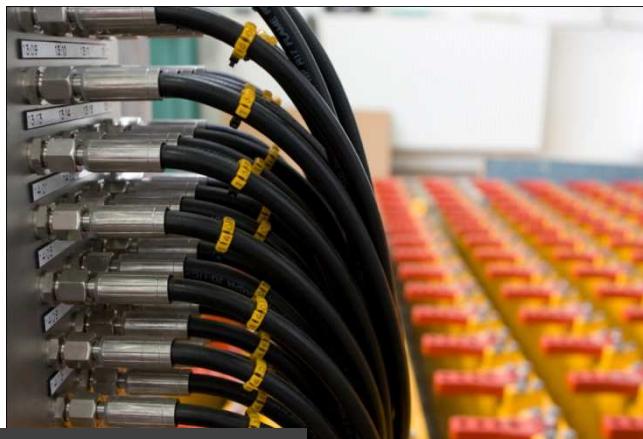
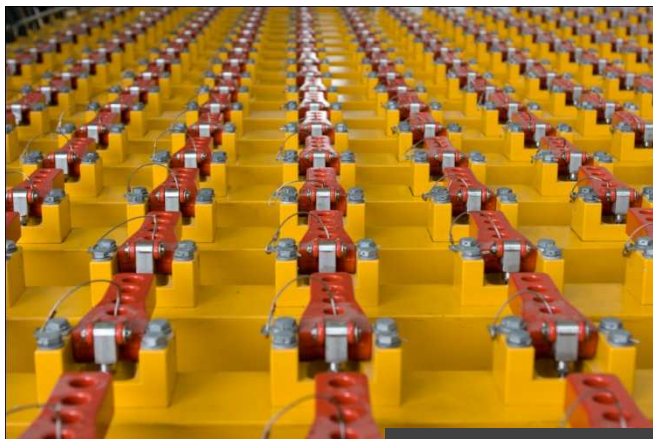

PNEUMATIC SYSTEM



ZBUD

HYDRAULIC ASSEMBLY PERFORMED BY ZBUD SYSTEM WALFORM / JIC73 / TRIPLELOCK



JIC37 / TRIPLELOCK



ZBUD HYDRAULIC ASSEMBLY PERFORMED BY ZBUD ELECTRICAL ASSEMBLY

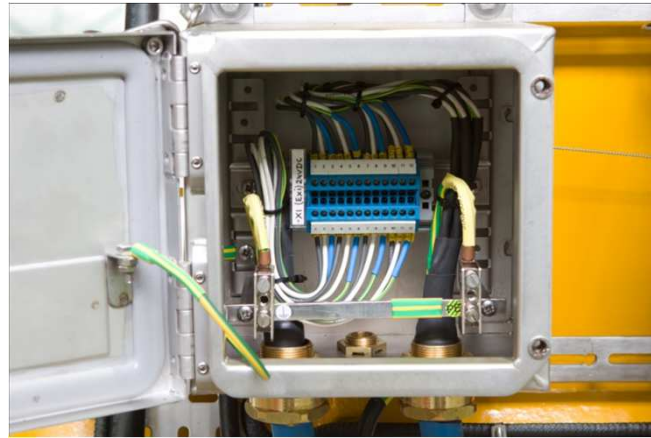

- QUALIFIED PERSONEL
- INSTALLATION ACC. TO CUSTOMERS
- STANDARD

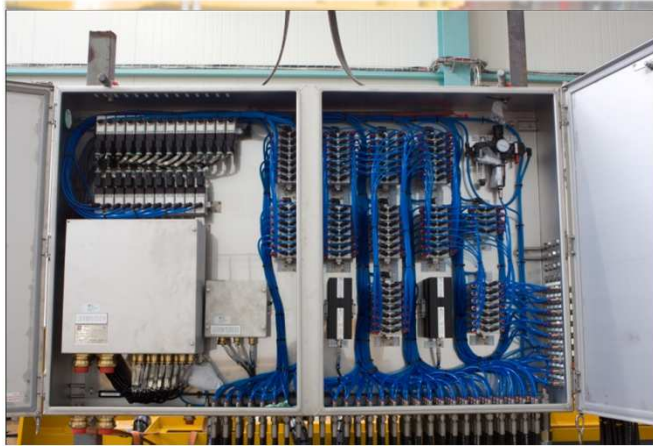

ZBUD - LIFTING SOLUTION

ZBUD

ZBUD - TESTING

6 TESTING TOWERS 18m HIGH

- STABBING BASKETS (UP TO 650KG AT 12M EXTENSION)
- WINCHES (UP TO 200 T)
- BOP CRANES 100T
- BRIDGE CRANES

CONFERENCE ROOM for IAT/FAT PURPOSE

TEST AREA INCLUDING 4 X 30 TONS FOUNDATIONS

OVERHEAD CRANES – LIFTING CAPACITY UP TO 60T

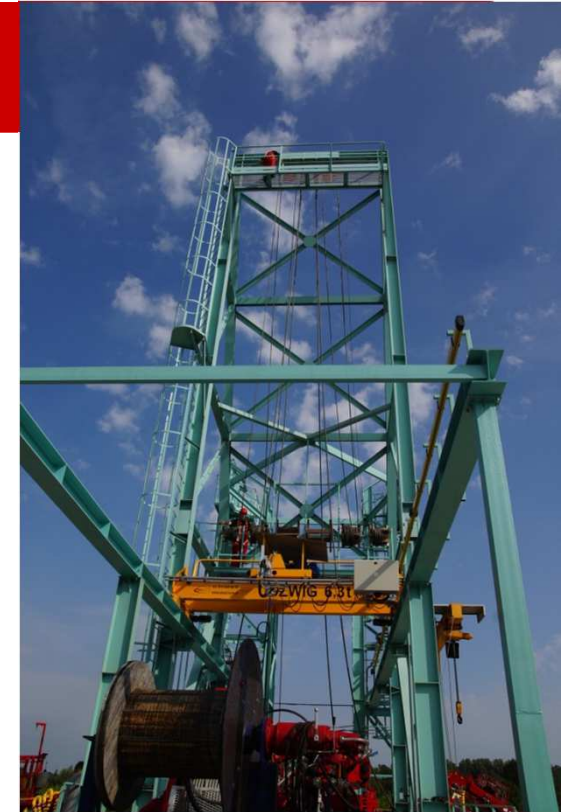

SPECIALIZED TEST TURRET
REAL CONDITION

ZBUD - LIFTING SOLUTION



ZBUD

ZBUD - TESTING

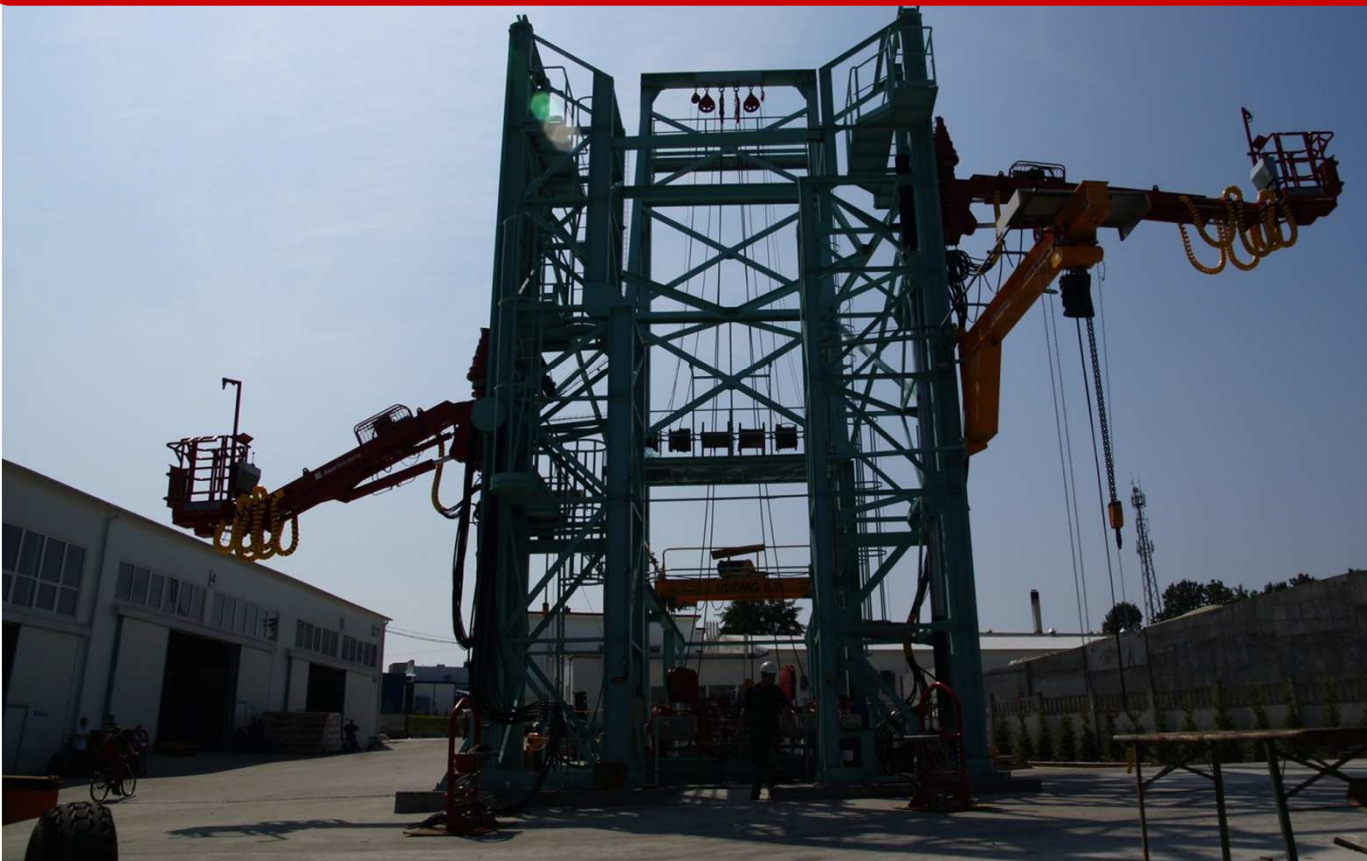

Go to next slide TESTING 2

ZBUD - LIFTING SOLUTION

SPECIALIZED TEST TURRET
REAL CONDITION

ZAKŁAD BUDOWY URZĄDZEŃ DŹWIGNICOWYCH ZBUD Sp. z o.o.



ZBUD

ZBUD FACILITIES
10 HYDRAULIC ASSEMBLY HALLS (40X20m each)



ZBUD - LIFTING SOLUTION



ZBUD

ZBUD FACILITIES CNC MACHINING HALLS- HEAVY MACHINES





ZBUD

ZBUD FACILITIES
PRECISE MACHINING HALL

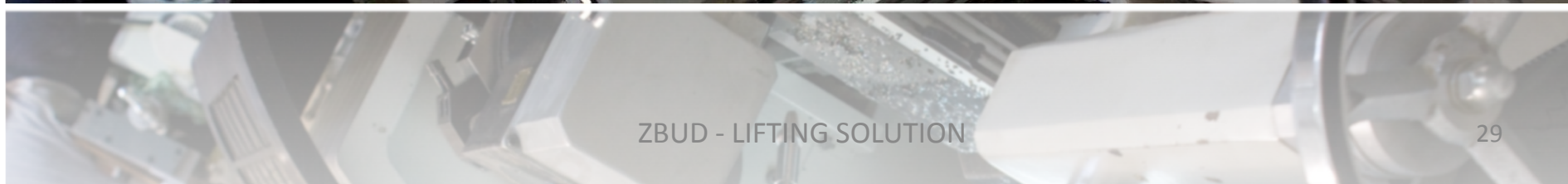

ZAKŁAD BUDOWY URZĄDZEŃ DŹWIGNICOWYCH ZBUD Sp. z o.o.



ZBUD

ZBUD FACILITIES
MACHINING HALLS - HEAVY MACHINES





ZBUD ZBUD MACHINES - HEAVY MACHINES



ZBUD - LIFTING SOLUTION



ZBUD

ZBUD FACILITIES
7 WELDING HALLS (40X20m)





ZBUD

ZBUD FACILITIES
7 PAINTING HALLS 3X SHOTBLASTING (36x4m)





ZBUD ZBUD MACHINES – CUTTING MACHINES
LASER / PLASMA / WATER JET CUTTING

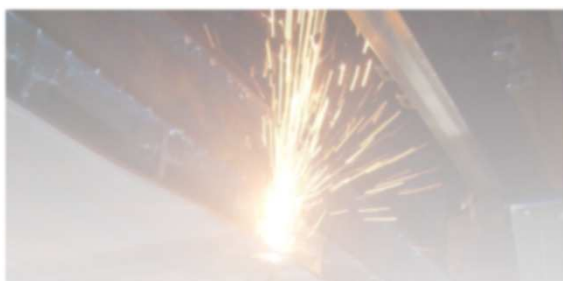

ZBUD - LIFTING SOLUTION



ZBUD ZBUD MACHINES – LATHES , MILLING MACHINES , DRILLING etc.





ZBUD ZBUD - CERTIFICATE



WOJSKOWY DOZÓR TECHNICZNY

DECYZJA NR 377-01/WDT/UTB/06
SZEFA WOJSKOWEGO DOZORU TECHNICZNEGO
z dnia 27.12. 2006 r.
w sprawie uprawnienia zakładu

Na podstawie art. 9 ust. 2 ustawy z dnia 21 grudnia 2000 r. o dozorze technicznym (Dz. U. Nr 122, poz. 1321 ze zm.)
uprawniam firmę

Zakład Budowy Urządzeń Dźwignicowych Sp. z o.o.
„ZBUD” Sp. z o.o.,
ul. Żabińska 6
33-200 Dąbrowa Tarnowska

do wytwarzania, naprawy i modernizacji:

- suwnic z napędem elektrycznym i ręcznym,
- żurawi stałych z napędem elektrycznym i ręcznym,
- wciągarek,
- wciągarek,
- dźwigników,

przeznaczonych dla Sił Zbrojnych Rzeczypospolitej Polskiej

zobowiązując do przestrzegania warunków uprawnienia stanowiących załącznik do niniejszej decyzji.

Załącznik: warunki uprawnienia.

Świadectwo Kwalifikacyjne
Nr 250/1294/2009

Spawalnictwa Komisja Kwalifikowania Zakładów Przemysłowych przy Instytucie Spawalnictwa w Gliwicach kwalifikuje

Zakład Budowy i Urządzeń Dźwignicowych
„ZBUD” Sp. z o.o.
33-200 Dąbrowa Tarnowska, ul. Żabińska 6
do I Grupy Zakładów Dużych
zgodnie z normą PN-48-6008

Uzyskana Grupa uprawnienia do prowadzenia prac spawalniczych w zakresie wykonawstwa, montażu i remontów spawanych konstrukcji stalowych klasy 1, 2 i 3, zgodnie z normą PN-48-6008, wykonywanych ze stali konstrukcyjnych, nierdzewnych, stali nisko i wysokoślownych oraz aluminium i jego stopów, następującymi metodami spawania:

- łukowego elektrodami otulonymi (111),
- łukowego w osłonie gazów metodą MAG (135) oraz TIG (141),
- łukowego, drutami proszkowymi w osłonie gazów aktywnymi (136),
- gazowego (311).

Pracownicy odpowiedzialni:

- za całokształt prac spawalniczych mgr inż. Maciej CISON EWE/ME EWE
Odszysk Spawark
- za kontrolę robót spawalniczych mgr inż. Wiesław MOTYKA
Kierownik Kontrolat Jakości

Świadectwo jest ważne do 29.04.2010 r.

PRZEWODNICZĄCY KOMISJA DYREKTOR INSTYTUTU
dr hab. inż. Jacek Szani EWE/ME EWE prof. dr hab. inż. Jan Flisak

Gliwice, 29.04.2009 r.

ISO 9001, ISO 3834

ZBUD - LIFTING SOLUTION



ZBUD

ZBUD - CERTIFICATE



- QUALIFICATIONS:
DESIGN, ASSEMBLY, SERVICE , MODIFICATIONS OF:
CRANES, JIB CRANES , HOISTS AND WINCHES AND STEEL STRUCTURES
- MILITARY QUALIFICATIONS
- QUALIFICATIONS TO MODIFICATIONS OF:
CRANES, WINCHES, HOISTS AND JIB CRANES
- CERTIFICATE OF ULTRASONIC TESTING UT-2
- CERTIFICATE OF MAGNETIC TESTING MT-2
- CERTIFICATE OF VISUAL TESTING VT-2
- DIE CERTIFICATE OF PENETRANT TESTING PT-2
- NDT CERTIFICATE



ISO 9001, ISO 3834

ZBUD - LIFTING SOLUTION



MANUAL CHAIN HOISTS THE FIRST PRODUCT MANUFACTURED BY ZBUD

Standard range of highly capacity 500[kg] -10[t]
Executed as individual and EX version

STATIONARY WŁ-S

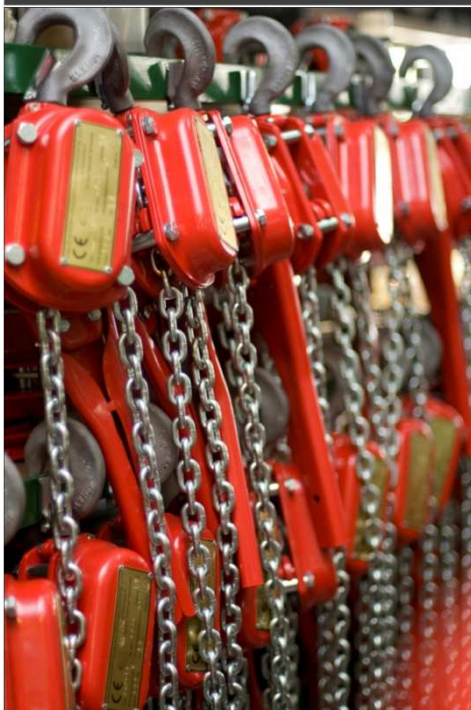

TRAVELLING WŁ-P



LEVER WŁ-G





WIRE ROPE HOISTS - THETA

DOMESTIC TECHNICAL IDEA COMBINED WITH COMPONENTS OF REPUTABLE SUPPLIERS

Standard range of highly capacity 500[kg] - 12,5[t]



THETA – result of longterm experience in lifting equipment

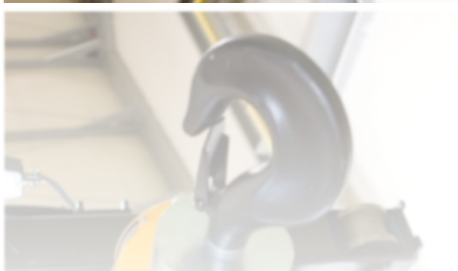

WIRE AND ELECTRIC ROPE WINCHES
PRODUCT CERTIFIED BY CLASSIFICATION SOCIETIES LIKE
DNV , PRS, LR , GL

Standard range of highly capacity 500[kg] -10[t]
Executed as individual and EX version



WIRE ROPE WINCHES WRL

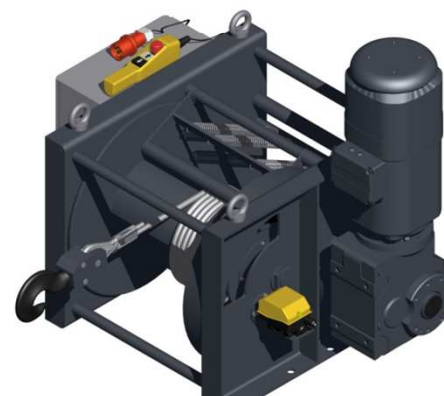

WIRE ROPE WINCHES WEL

TROLLEYS DEDICATED FOR A HORIZONTH LOAD MOVEMENT

Executed as individual and EX version

TYP WS
do to be used with stationary hoist



TYP WS-P
To be used with travelling hoist





JIB CRANES
THE EXCELLENT WAY TO INCREASE EFFICIENCY, COMFORT AND WORKING SAFETY

Standard range of highly capacity 250[kg] - 10[t]

JIB CRANES ZSL ZSW ZSXL



TYPE ZSL



TYPE ZSX

Equipped with manual or electric hoist



Go to next slide JIB CRANES 2

ZBUD - LIFTING SOLUTION



JIB CRANES
THE EXCELLENT WAY TO INCREASE EFFICIENCY, COMFORT AND
WORKING SAFETY

Standard range of highly capacity 250[kg] - 5[t]

WALL MOUNTED JIB CRANES ZPL ZPX ZPXL



TYPE ZPX

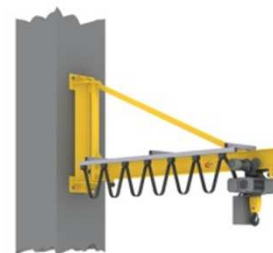

TYPE ZPL

Equipped with manual or electric hoist





OVERHEAD CRANES ZBUD-POLISH LEADER IN CRANES MANUFACTURERS

ZBUD-POLISH LEADER IN CRANES MANUFACTURERS

Standard range of highly capacity 100[kg]-80[t]

OVERHEAD CRANES
SINGLE AND DUBLE GIRDER
TYPE ZXJ ZXD

GANTRY CRANES TYPE ZXB

SUSPENDED CRANES TYPE MASTER SINGLE
AND DUBLE GIRDER

SUSPENDED OVERHEAD CRANES TYPE ZXJP

MARINE CRANES

MOBILE GANTRY

CABINS FOR INSTALLATIONS ON OVERHEAD
CRANES

Pararel to overhead cranes, ZBUD is manufacturing steel structures



Go to next slide CRANES

ZBUD - LIFTING SOLUTION



OVERHEAD CRANES

ZBUD-POLISH LEADER IN CRANES MANUFACTURER

OVERHEAD CRANES
SINGLE AND DOUBLE GIRDER
TYPE ZXJ



Go to next slide JIB CRANES 3

ZBUD - LIFTING SOLUTION



OVERHEAD CRANES
ZBUD-POLISH LEADER IN CRANES MANUFACTURER

ЗВОД-ПОЛІСЬН ГЕВДЕК ІН СКАМІЄЗ ВУИПЕАСТОВЕК

OVERHEAD CRANES
SINGLE AND DUBLE GIRDER
TYPE ZXD



ZBUD - LIFTING SOLUTION



GANTRY CRANES ZBUD-POLISH LEADER IN CRANES MANUFACTURER

ЗВОД-ПОЛІСЬ ПЕВДЕК ІН СКАІЕ? ВУИПЬАС ІОКЕК

GANTRY CRANES TYPE ZXB

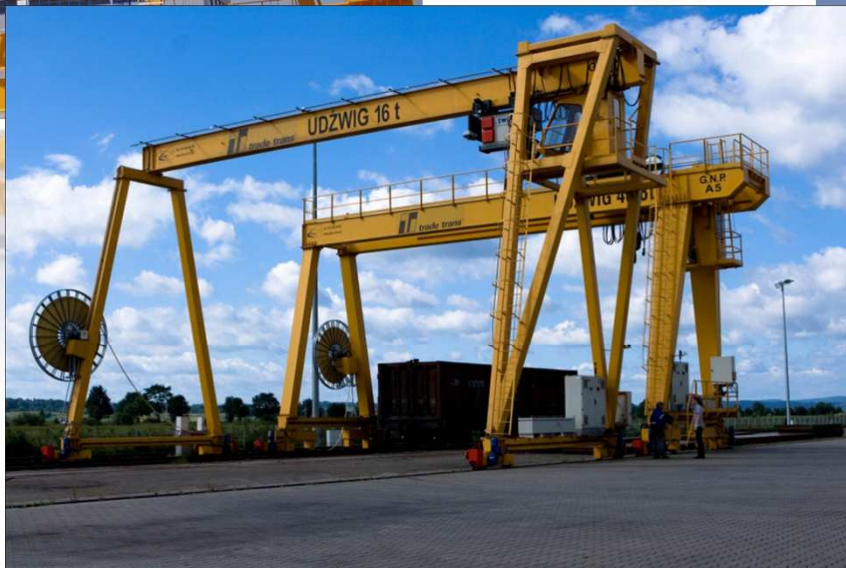
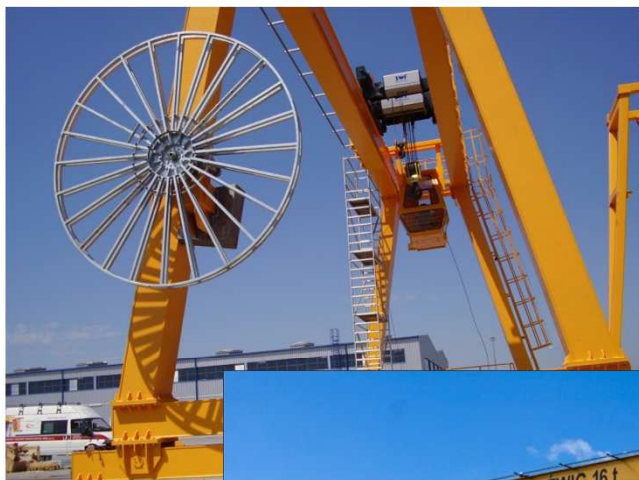

OFFSHORE PROJECT

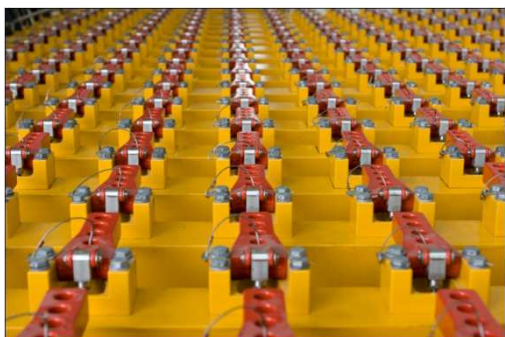

FINGERBOARD



RACKING ARM



ZBUD - LIFTING SOLUTION



Go to next slide OFFSHORE 2

OFFSHORE PROJECT

SERVICE BASKET



WINCH



ZBUD - LIFTING SOLUTION



Go to next slide OFFSHORE 3



ZBUD

OFFSHORE PROJECT - HYDRARACKER



Go to next slide OFFSHORE 4

ZBUD - LIFTING SOLUTION

OFFSHORE PROJECT - HYDRAULIC CHAIN HOIST



BOB HANDLING SYSTEM
SERVICE HOISTS



OFFSHORE PROJECT HYDRAULIC CHAIN HOIST

BOB alone is great but 2 BOB's are even better !

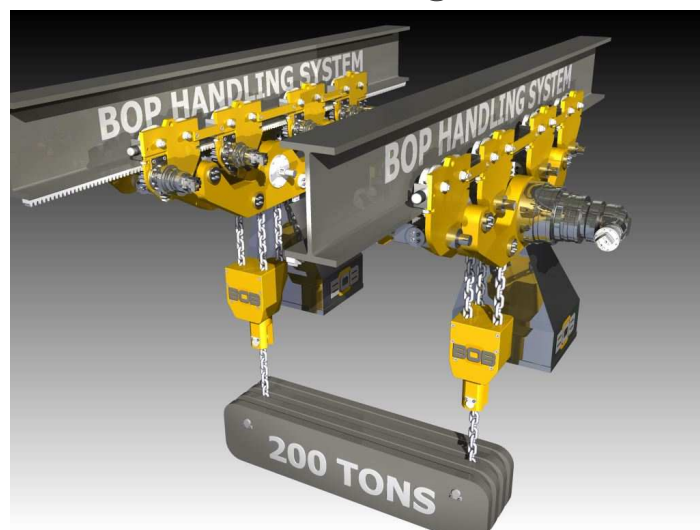

Designed to work in a tandem
as dedicated BOP Handling System
with capacity up to 200MT



OFFSHORE PROJECT HYDRAULIC CHAIN HOIST



Electric winch for pulling
and lifting Type WEL



ZBUD LIFTING SOLUTION



www.zbud.com.pl

ZAKŁAD BUDOWY URZĄDZEŃ DŹWIGNICOWYCH ZBUD Sp. z o.o.

THE END

